

Article number: 07122401001

Description: Universal joint single 0.122.401.001
S=220 X= Bore with keyway

Measures

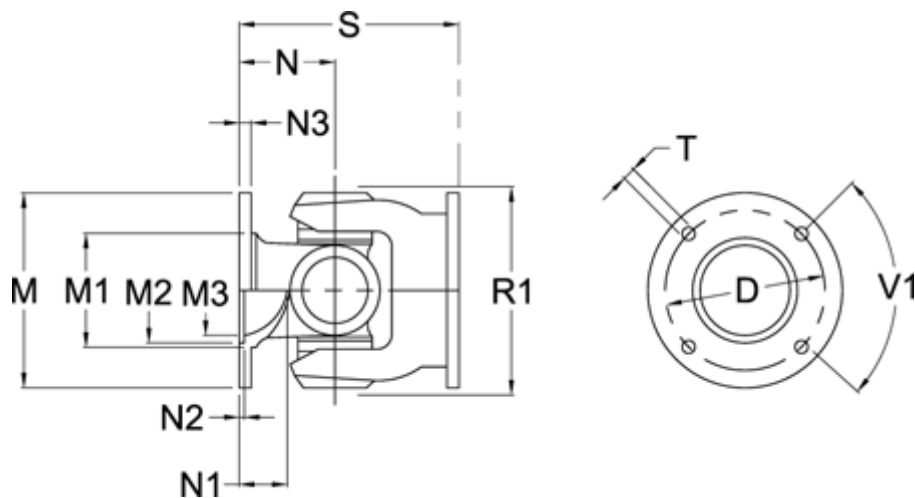

D	= 196 +0,1	N2	= 5 +0,5
Flange diameter M	= 225	N3	= 15
M1	= 160	Number og Flangeholes	= 12
M2	= 140	R1	= 204
M3	= 128	S min	= 220
Max. Bending Angle degrees	= 30	T	= 16 B12
N	= 110	V1 degrees	= 30
N1	= 36		